

Shelbourne

REYNOLDS

100, 150 AND 300 MODELS OPERATORS MANUAL 2019 ONWARDS



Shelbourne Reynolds Engineering Ltd
Stanton
Bury St Edmunds
Suffolk
IP31 2AR
England

Telephone: 01359 250415
Fax: 01359 250464

Stores Direct : 01359 251231
Stores Direct: 01359 252031

ISSUE 3

11/04/2023

www.shelbourne.com



CUBICLE BEDDER

DEALER PRE-DELIVERY / INSTALLATION CHECK AND WARRANTY REGISTRATION – CUBICLE BEDDER

DEALERS PRE-DELIVERY / INSTALLATION CHECK

IMPORTANT Δ

All items listed below must be checked, and adjusted if necessary. The person conducting the inspection should tick each item in the space provided, indicating whether or not adjustments were required. In the event of additional work being needed, details should be given in the additional work / discrepancy box, located at the bottom of this sheet, or on a separate sheet if required. When the inspection is complete, THIS FORM MUST BE COPIED & RETURNED TO:- Shelbourne Reynolds within 30 days of delivery to customer, otherwise the invoice date to the dealer will be deemed to be the start date for the warranty period.

SERIAL NUMBER: MACHINE NUMBER:.....

MODEL:

PLEASE TICK APPROPRIATE COLUMN FOR EACH ITEM UNDERTAKEN

Dealer Pre Customer Delivery / Installation / Commissioning	Checks OK	Adjusted
Ensure the Cubicle Bedder is correctly mounted to the tractor or handler.(see section 2.4)		
Check hydraulic flow on the tractor or handler to ensure the optimum size conveyor motor is fitted.		
Ensure the hoses are not taught when the Cubicle Bedder is connected to the prime mover vehicle.		
Check the agitator tine configuration suits the recommended setting for the material being spread. (see section 5.14)		
Check the internal metering plates are set at the recommended distance for the material being spread. (see section 5.13)		
Lubricate all grease points.(see section 7.1)		
Check hydraulic system for leaks.		
Check operation of hydraulic services.		
Ensure that all safety guards & decals are fitted.		
Check paintwork & finish.		
Check in general that nuts & bolts are tight.		
Ensure that an Operator's manual is supplied with the machine.		
Additional Comments:		
Dealer Representative's Name:		Date:

Customer Instruction	Actioned
Explain the correct setting & operation of the machine to the customer.	
Ensure the maintenance schedule is explained to the customer.	
Ensure all spare agitator tines are handed to the customer for storage.	
Ensure the lubrication & grease points are indicated to the customer.	
Ensure all safety precautions & safety signs are explained to the customer.	
Ensure the warranty policy is explained to the customer.	
Ensure that the operator's manual is handed to the customer.	
Additional Comments:	
Dealer Representative's Name: Date:	

For specific details please refer to the operator's manual.

WARRANTY POLICY (ALL PRODUCTS)

MACHINE REGISTRATION

To qualify for the full benefit of the warranty set out in this warranty policy (the “**Warranty**”), it is the purchaser’s responsibility to ensure that the Shelbourne authorised dealer has completed the warranty registration details and that they are submitted to Shelbourne Reynolds Engineering Ltd. within 15 days from the date of delivery. If the warranty registration has not been completed and returned to warranty@shelbourne.com before the expiration of 15 days from the date of delivery, any claims made will be refused.

Using the machine implies the knowledge and acceptance of these warranty terms.

1. LIMITED WARRANTIES

1.5 NEW MACHINE WARRANTY

All new machines supplied by **Shelbourne Reynolds Engineering Ltd. (“Shelbourne”)**, are warranted to the original purchaser, under normal use and service, to be free from defects in material and workmanship for a period of 12 months from the date of delivery to the original purchaser (the **Warranty Period**), subject to the terms set out in this warranty policy.

No other warranty is given by Shelbourne regarding the machine, and no person has any authority to give any such warranty for or on behalf of Shelbourne, other than were given in writing signed by a director of Shelbourne.

1.2 WARRANTY ON SPARE PARTS

Shelbourne warrants that any spare part or component supplied by Shelbourne or the Shelbourne authorised dealer in accordance with this limited warranty are free from defects in material or workmanship from the date of sale to the original purchaser for 6 months, subject to the conditions and limitations in clauses 2 to 5 of this warranty policy. Shelbourne will at its option, either repair or replace the defective part free of charge providing that any warranty claim is supported with a copy of the invoice to the end user for the failed part. No claims will be considered for which sales invoices are not provided. Original Purchaser shall be responsible for labour and all freight charges to and from the place where the warranty work is performed.

Shelbourne Reynolds Engineering Ltd. cannot be held responsible for any failures or safety implications arising from the use of non-genuine parts. Use of non-genuine parts may seriously affect the machine’s performance and safety.

1.3 WARRANTY ON DEALER STOCK MACHINES

No warranty is available or will be given on machines held in dealer stock for more than 6 months before sale.

1.4 TRANSFER OF WARRANTY

Shelbourne may at its sole discretion allow this warranty to be transferred to a subsequent owner of the machinery for the balance of the Warranty Period, subject to all the warranty conditions being met and only with Shelbourne giving prior written consent.

1.5 EXTENDED WARRANTY - Only available on the following Trimmer & Powermix Ranges

Trimmer – 7000 & 8000 Series

Shelbourne will provide an extended Warranty on certain parts of the 7000 and 8000 Trimmer ranges for an additional 12 months, beyond the initial Warranty Period. This is indicated in the table below and is subject to all the other terms and conditions of this warranty policy. This is a conditional extended warranty offered solely at the discretion of Shelbourne and is on a parts only basis.

	Standard (0-12 months)	Extended (12-24 months)
Gearbox	✓	✓
Hydraulic Valves	✓	✓
Hydraulic Pump	✓	✓
Hydraulic Motor	✓	✓
Hydraulic Cylinders	✓	✓
Booms/Main Frame	✓	✓
PTO Shaft	✓	X
Electronic Controls	✓	✓
Hoses	✓	X
Joystick	✓	X

X = Not Covered ✓ = Covered

Note: Components not indicated have a Shelbourne standard 12 months warranty and are subject to all other terms and conditions of this warranty policy.

Powermix - All Models

Shelbourne will provide an extended Warranty on certain parts of all Powermix models for an additional 12 months and 24 months beyond the initial Warranty Period. This is indicated in the table below, and subject to all the other terms and conditions of this warranty policy.

This is a conditional extended warranty offered solely at the discretion of Shelbourne and is on a parts only basis. It is contingent on the recommended service schedule outlined in the operator’s manual being followed and in the event of a claim proof of servicing will be required.

	Standard (0 - 12 months)	Extended (12 - 24 months)	Extended (24 – 36 months)
PTO Shaft	✓	X	X
Planetary Gearbox	✓	✓	✓
2 Speed Gearbox	✓	✓	✓
Hoses	✓	X	X
Scale Head	✓	✓	X
Electronic Controls	✓	X	X
Load Cells	✓	X	X
Valve Block	✓	X	X
Conveyor Belt	✓	X	X

X = Not Covered ✓ = Covered

Note: Components not indicated have a Shelbourne standard 12 months warranty and are subject to all other terms and conditions of this warranty policy.

2. EXCLUSIONS

Shelbourne will not be liable for the machine's failure to comply with the Warranty in any of the following circumstances:

- 1) damage due to improper use or abusive operation
- 2) damage or depreciation caused by normal wear and tear.
- 3) the machine been subjected to alteration, modification, or fitment of non-genuine Shelbourne parts without the prior consent of Shelbourne.
- 4) wilful or accidental damage, including (but not limited to) damage caused by contact with overhead power lines, damage caused by foreign objects (e.g., stones, metals, and any materials other than vegetation).
- 5) the machine has not been maintained and serviced fully in accordance with the details and maintenance schedule set out in the Shelbourne Operators Manual, and only using Shelbourne genuine parts. Proof of service work may be requested prior to approval of any claim under the Warranty.
- 6) failure due to use of incorrect oil or lubricants, contamination of the oil, or oil which has served its useful life or failure to carry out proper maintenance as recommended in the Shelbourne Operators Manual.
- 7) the original purchaser failed to follow Shelbourne's oral or written instructions (including instructions in the Shelbourne Operators Manual) for the transportation, storage, commissioning, installation, use and maintenance of the machine or (if there are none) good trade practice regarding the same.
- 8) where the original purchaser has continued to use the machine after they became (or should reasonably have become) aware of the defect with the machine. **Continued use of the machine after a defect is discovered could cause further failures for which Shelbourne cannot be held liable and may also have safety implications.**
- 9) the Shelbourne serial number plate on the machine has been removed or altered.
- 10) failure by the customer to release the machine for repair will not be accepted as a reason for delay in repair or submitting warranty claims.
- 11) the product is attached to, connected with, or used in conjunction with, any other product which it is not compatible for use with (whether that other product is a Shelbourne or non-Shelbourne product);

In addition, it is the purchaser's responsibility to ensure that where the purchased Shelbourne product is to be attached to a tractor or other vehicle, the product falls within the carrying capacity as well as compatibility of the tractor or machinery which it is to be mounted on or to. Acceptance of an order and the supply of a product by Shelbourne does not indicate Shelbourne's approval of the purchaser's intended choice of tractor or machinery for installation, nor its compatibility with the purchased Shelbourne product.

The Warranty shall not apply in respect of any:

- 1) wearing items including but not limited to drive belts, conveyor belts, conveyor rollers, rubber flaps, flails, skids, bearings, pins, bushes, blades, pneumatic tyres, or any other items which are soil engaging or normal wearing or consumable items
- 2) hoses that have suffered external damage. Complete hoses must be returned for warranty within this period. Any which have been cut or repaired will be rejected.
- 3) repeat or additional repairs resulting from incorrect diagnostics, unless advised by Shelbourne.
- 4) poor-quality previous repair work (unless carried out by Shelbourne).

3. LIMITATIONS OF LIABILITY

Shelbourne and the Shelbourne authorised dealer shall not be liable to the original purchaser under any circumstance for injuries, death, property damage or damages of any kind whatsoever directly, consequential, or contingent to any person or property caused by the use of the machine.

Shelbourne shall not be liable for any consequential loss such as the following costs or types of loss (whether direct or indirect):

- 1) Loss of profit;
- 2) Loss of or damage to goodwill;
- 3) Loss of sales or business;
- 4) Loss of agreements or contracts or business opportunity;
- 5) The cost of lost consumables (such as oil);
- 6) Any loss or costs arising from the inability to use the machine due to any defect with the machine, and during the time taken to repair or replace the machine;
- 7) The cost of hire or purchase of any replacement machine;
- 8) Recovery of broken-down machine;
- 9) Damage to or loss of crops or vegetation;
- 10) Labour cost;
- 11) Damage to carrying tractor;
- 12) Damage caused by exceeding the tractor OEM (original equipment manufacturers) specification for implement mounting and hitch capability; and
- 13) Any other indirect or consequential loss.

In view of the Warranty given by Shelbourne, the terms implied by sections 13 to 15 of the Sale of Goods Act 1979, and all other implied warranties or conditions regarding the quality or suitability of the machine, are, to the fullest extent permitted by law, excluded from this warranty policy and any contract or agreement between Shelbourne and either the original purchaser or the Shelbourne authorised dealer.

The liability of Shelbourne for any failure by the machine to comply with the Warranty shall be limited to repair or replacement of the product, or refund of the purchase price, of the product as set out in clause 4 of this warranty policy.

Nothing in this warranty policy limits any liability which cannot legally be limited, including liability for:

- 1) death or personal injury caused by negligence.
- 2) fraud or fraudulent misrepresentation.

- 3) breach of the terms implied by section 12 of the Sale of Goods Act 1979 (title and quiet possession); and
- 4) breach of section 2 of the Consumer Protection Act 1987.

4. WARRANTY CLAIMS

All claims must be submitted by a Shelbourne authorised dealer on behalf of the original purchaser, providing that the original purchaser has:

- 1) given notice in writing with full information regarding the failure, to Shelbourne (or the Shelbourne authorised dealer) during the Warranty Period, and within 15 days of discovery of the failure. The Shelbourne authorised dealer will be responsible for forwarding the claim to Shelbourne directly, and where appropriate, the Shelbourne authorised dealer may be responsible for dealing with warranty claims as directed by Shelbourne;
- 2) given Shelbourne (or the Shelbourne authorised dealer) a reasonable opportunity to examine the machine or the damaged or defective parts; and
- 3) if requested by Shelbourne (or the Shelbourne authorised dealer), returned the damaged or defective parts (via the original Shelbourne authorised dealer) within 30 days of notification of a defect, as long as the request by Shelbourne (or the Shelbourne authorised dealer) is made within that time frame, otherwise, within a time frame as specified by Shelbourne (or the Shelbourne authorised dealer).

then Shelbourne shall, at its option, repair or replace the defective parts, or refund the price of the defective parts or approve that the Shelbourne authorised dealer does the same.

5. REPAIR COSTS

The original purchaser or Shelbourne authorised dealer shall not repair, or arrange for a repair, of the machine without the prior written authority of Shelbourne. Such authority may only be given by Shelbourne service personnel. **Shelbourne will not be liable for the cost of any repairs carried out without its prior written consent to the work being done.**

If Shelbourne authorises a repair of the machine, all claims for repair costs must be submitted to Shelbourne by a Shelbourne authorised dealer within 15 days of the date of repair on a Shelbourne Warranty Claim Form (in accordance with clause 7 of this warranty policy).

Repairs should only be completed by a Shelbourne authorised dealer (or another repairer with the prior written consent of Shelbourne).

The submission of a claim is not a guarantee of payment. Shelbourne will only reimburse the reasonable costs and expenses incurred in connection with any repair. The decision reached by Shelbourne is final.

6. DAMAGE TO NEW MACHINES

All goods must be examined on receipt, please examine all machines and packages, if there is any damage or short shipment sign 'Damaged' or 'Detail any item not received' and notify both Shelbourne Reynolds warranty department by phone or E Mail and the carrier within 24 hours of any damage or missing parts. **No claims will be accepted after this time.**

7. CLAIMS PROCEEDURE

All claims must be submitted by a Shelbourne authorised dealer. Full information relating to the failure must be submitted using the claim form available on the Shelbourne website under the "Support" section, with all required fields completed with the relevant information and then emailed to warranty@shelbourne.com. Full information on warranty claim submission can be found set out in the warranty procedures document.

Where repairs are completed by a Shelbourne authorised dealer (or another repairer with the prior written consent of Shelbourne), then completed form(s) must be received by Shelbourne **NOT LATER THAN 15 DAYS** from the date of repair. When requested by Shelbourne, additional information or failed parts must be received by Shelbourne **WITHIN 15 DAYS** of claim submission.

If in exceptional circumstances a non-Shelbourne part is used for a repair, warranty reimbursement will be at no more than Shelbourne's standard dealer cost for the genuine part.

If parts are returned and the claim is subsequently rejected and you require the parts sent back to you, please notify Shelbourne within 7 days of receiving rejection notification.

Following examination of the claim and parts, Shelbourne will pay at their discretion, for any valid claim the invoiced cost of any parts supplied by Shelbourne and appropriate labour and mileage allowances if applicable. **Maximum mileage per claim is capped at 80 miles unless otherwise pre-authorised and confirmed in writing by the Shelbourne Reynolds Service Manager.**

For any claims submitted, which are intentionally misleading or fraudulent, Shelbourne shall be entitled to charge an appropriate hourly rate to recover any costs incurred as a result.

8. FAILED PARTS

Ensure that all hydraulic ports on returned components are drained of oil and securely and appropriately plugged with the caps that came fitted to the replacement components to avoid oil leakage and contamination entering the assemblies. Hydraulic cylinders must be cleaned of oil and fully retracted.

Electrical items being returned must be suitably packaged and protected to reduce the risk of transportation damage.

Due to strict time constraints enforced by our suppliers, you must immediately return any failed hydraulic components such as pumps, motors, cylinders, valves, and hoses; electrical components, such as solenoid valves, control boxes, sensors/switches; or driveline components such as gearboxes, PTOs, and bearings if the machine is still within its relevant warranty period.

Hydraulic parts such as pumps, motors and cylinders, and driveline parts such as gearboxes must be returned to us unopened and unexamined. With hydraulic valve blocks and electrical control boxes there is the ability to replace specific serviceable components within them, such as valve cartridges, spool assemblies, circuit boards, relays, switches, and joystick should the need arise to resolve a fault within.

Any parts replaced under warranty remain the property of Shelbourne. They must be returned to Shelbourne on request. In all other cases, unless informed otherwise, they must be retained for a period of 90 days after such time they must be destroyed and rendered physically unusable and not sold or reconditioned for sale to a third party.

9. REIMBURSEMENT

All claims, to the extent which it has been agreed by Shelbourne that a refund will be made, will be settled with the Shelbourne dealer, by credit memo, within 30 days of acceptance of the claim.

10. EXPORT CUSTOMERS

If you are based outside of the UK, warranty terms and conditions outlined above may differ depending on your market. Please contact Shelbourne Reynolds Engineering Ltd. for further information.

Dear Customer,

Parts manuals are not supplied with this machine, but they can be ordered from your Shelbourne Reynolds dealer. Alternatively they can be downloaded from the Shelbourne Reynolds website www.shelbourne.com by clicking on the Parts and Service section of the website, and then selecting manuals followed by Cubicle Bedder Manuals.

The Machine and Parts Manual Number for your machine is -

Tick	Machine No.	Manual No.	Machine Description
	269902 01	MAN-13000	Cubicle Bedder 100
	269902 02	MAN-13000	Cubicle Bedder 150
	269902 03	MAN-13000	Cubicle Bedder 300
	269903 02	MAN-13000	Cubicle Bedder 150 (Straw Rotor)

Cubicle Bedder Serial Number

CUB

ORDERING SPARE PARTS

To ensure that you order the correct part from your SRE dealer please use the following procedure.

ALWAYS QUOTE THE MACHINE AND SERIAL NUMBERS WHEN ORDERING.

Refer to the Parts Manuals front page/s, listing the machine numbers. Select the correct machine number which is printed in the top left corner of the page (starting with 2699__ _01).

The machine number is listed above or can be found printed on the identification plate, which is located on the rear of the tub.

Scan down the page, and select the relevant sub assembly your required part falls within. Sub-assemblies start from 2690__ _01. Note the year or serial number of the machine may determine a correct sub assembly if more than one is listed.

Continue through the manual and find the relevant sub assembly parts listing. Again the number will be printed in the top left corner; the sub-assemblies are in numerical order.

Having found the correct parts list, you will find the corresponding drawing by either looking at the facing page or progressing through the manual to the next drawing. The drawings indicate the components by item numbers, which you will find, are repeated in the left-hand side of your parts listing, and therefore referring to the correct part.

Please note that if certain parts cannot be found listed below the sub-assembly numbers, they are likely to form part of a specific optional kit. These kits will be found in numerical order further through the manual and start with KIT- _ _ _ _ _

The list below highlight the optional build kits that also make up your exact configuration of machine.

Non-current production highlighted

Tick	Part No.	Description
Optional Kits		
	KIT-26005	Agitator direct drive kit
	KIT-26006	Agitator chain drive kit
	KIT-26007	3 point tipping 'A' frame kit
	KIT-26008	3 point fixed mounting kit
	KIT-26009	Agitator chain drive conversion from direct drive
	KIT-26011	Chain drive upgrade kit
	KIT-26012	Agitator chain drive conversion from direct drive
	KIT-26014	Pressure/flow controlled valve kit
	KIT-26016	Loader bracket clamp plate kit (100 model)
	KIT-26018	Agitator chain drive kit
	KIT-26021	Straw Rotor Kit
	KIT-26022	Agitator Kit
	KIT-26023	Shipping stand kit
Conveyor drive hydraulic motor options, when not standard MOTH04001		
	MOTH03200	Hydraulic motor, to suit 24-28 lpm
	MOTH02500	Hydraulic motor, to suit 19-22 lpm
	MOTH04001MS	LOSI conveyor motor
Other motors and hydraulic options		
	MOTH39641	LOSI agitator motor
Axle Options		
	KIT-25050	JCB Q Fit bracket kit (HD brackets)
	KIT-25051	Manitou bracket kit
	KIT-25052	Merlo bracket kit (60 degree angle)
	KIT-25053	Matbro bracket kit
	KIT-25054	Claas (Scorpion) bracket kit
	KIT-25055	Euro loader bracket kit
	KIT-25056	Bracket plate kit (for welding own brackets to)
	KIT-25057	CNH bracket kit
	KIT-25058	Schaeffer bracket kit
	KIT-26060	Chilton/MX bracket kit
Extras		

EC Declaration Of Conformity For Machinery

(Machinery Directive 2006/42/EC, Annex II., sub. A)

Manufacturer : Shelbourne Reynolds Engineering Ltd.

Address : Shepherds Grove Industrial estate,
Stanton,
Bury St Edmunds,
Suffolk.
England.
IP31 2AR

Name and address of the person (*established in the European Community/EEA*)
authorised to compile the technical file (*to the authorities on request*):

Name : Mr. Neil Smith

Address : As stated above.

Herewith we declare that :	DESIGNATION:	<input type="text" value="CUBICLE BEDDER"/>
	MODEL:	<input type="text"/>
	TYPE:	<input type="text"/>
	MACHINE No.:	<input type="text"/>
	SERIAL No.:	<input type="text"/>

- is in conformity with the relevant provisions of the Machinery Directive (2006/42/EC)



Neil Smith
Director

Place :

Date :

PARTS AND OPERATORS MANUAL

CONTENTS

Section 1	INTRODUCTION
1.1	Foreword
1.2	Improvements and changes
1.3	Service Parts
1.4	Machine Identification
Section 2	SAFETY PROCEDURES
2.1	Accident prevention
2.2	Safety signs
2.3	Accident prevention before starting the machine
2.4	Accident prevention when attaching and detaching to the tractor, handler or loader
2.5	Accident prevention when using the hydraulic system
2.6	Accident prevention when operating
2.7	Accident prevention when leaving the machine
2.8	Accident prevention when servicing / adjusting the machine
2.9	Accident prevention when taking on public roads
2.10	Accident prevention when cleaning and storing machine
2.11	Noise emissions
2.12	Proper use
2.13	No liability for consequential damage
Section 3	SPECIFICATION AND DESCRIPTION
3.1	Description
3.2	Intended use
3.3	Technical Specification
Section 4	TRANSPORTATION
Section 5	PREPARATION FOR USE
5.1	Fitment of 3 point hydraulic tipping 'A' frame kit
5.2	Fitment of fixed 3 point linkage kit
5.3	Conversion of agitator chain drive from direct drive
5.4	Conveyor motor options
5.5	Handler or loader bracket fitment
5.6	Attachment to a tractor using fixed 3 point linkage
5.7	Attachment to a tractor using 3 point tipping 'A' frame
5.8	Attachment to a handler or loader
5.9	Removal from a tractor using fixed 3 point linkage
5.10	Removal from a tractor using 3 point tipping 'A' frame
5.11	Removal from a handler or loader
5.12	Initial machine run up
5.13	Metering plates

5.14 Agitator tines

Section 6 OPERATION

6.1 Loading the machine

6.2 Discharging the bedding material

6.3 Fine tuning of discharging the bedding material

6.4 Clearing a blockage

Section 7 MAINTENANCE

7.1 Lubrication

7.2 Agitator chain drive tension

7.3 Belt tensioning and tracking

7.4 Storage

Section 8 PARTS LISTINGS

SECTION 1

INTRODUCTION

1.1 FOREWORD

This manual will assist the operator to set, operate and service the Shelbourne Reynolds Cubicle Bedder to produce safe and efficient operation. It should be read carefully before putting the machine to work. Later sections illustrate and list all relevant spare parts. This manual should be used in conjunction with the tractor, handler or loader manufacturers manual.



1.2 IMPROVEMENTS AND CHANGES

Shelbourne Reynolds Engineering are continually improving their products to meet the farmers needs and therefore reserve the right to make improvements and changes when practical to do so, without incurring any obligation to make changes and additions to equipment which has been sold previously.

1.3 SERVICE PARTS

Use guaranteed and genuine Shelbourne Reynolds engineering service parts on Shelbourne Reynolds machinery to ensure maximum life and best performance. These are available through your Shelbourne Reynolds Engineering dealer.

When ordering service parts always quote the model, serial number and machine number.

1.4 MACHINE IDENTIFICATION

The serial and machine numbers of the Cubicle Bedder are printed on a plate located on the rear panel of the tub.

<i>Shelbourne</i>	
REYNOLDS	
SHELBOURNE REYNOLDS ENGINEERING LTD, STANTON, SUFFOLK, UK. IP31 2AR.	
TEL: +44 (0)1359 250415 WWW.SHELBOURNE.COM	
CE	
SERIAL NO.	<input type="text"/>
TYPE	<input type="text"/>
M/C NO.	<input type="text"/>
FOR SPARES QUOTE BOTH SERIAL NO. AND MACHINE NO.	
DESIGNATION	<input type="text"/>
YEAR	<input type="text"/>
MAX TOTAL WEIGHT	<input type="text"/>
UNLADEN WEIGHT	<input type="text"/>
FRONT AXLE LOAD	<input type="text"/>
REAR AXLE LOAD	<input type="text"/>
DRAWBAR MAX LOAD	<input type="text"/>
SHELBOURNE REYNOLDS INC. PO BOX 607, COLBY, KANSAS 67701, USA. PH: 785-462-6299	

SECTION 2

SAFETY PROCEDURES

2.1 ACCIDENT PREVENTION

The following safety instructions are applicable for all chapters of this manual.

Accident programmes can only prevent accidents with the co-operation of the persons responsible for the operation of the equipment.

For safety of yourself and others, operate equipment with care and do not take unnecessary risks, which could cause an accident.

Please read all safety instructions contained in this operating manual with the utmost care and also observe all safety signs attached to the Cubicle Bedder. Follow these instructions to prevent accidents. These instructions must also be made available to all other users. You are advised to refrain from any working methods, which may be hazardous.

All relevant accident prevention regulations governing the operation of agricultural machinery, as well as other generally acknowledged health and safety regulations and road traffic regulations must be strictly observed.

The tractor, handler or loader manufacturer's operator's manual, safety precautions should also be adhered to when using the Cubicle Bedder.

CAUTION



This symbol will appear throughout this manual whenever your safety, the safety of others or the machinery, is involved.

2.2 SAFETY SIGNS

The following safety signs appear on the machine and are for your safety and the safety of other people. Ensure that you identify each symbol and understand its warning.



These safety signs must be kept in a legible condition and must be replaced if missing or damaged. This is especially the case when whole sections are replaced when making repairs. Replacement safety signs are available as spare parts through your dealer or importer.

Standard safety signs on all models.

Stop the engine and remove the key from the tractor / handler's ignition before carrying out any work on the machine.

Carefully read the operating manual before handling the machine

Risk of crushing of torso. Do not stand between Cubicle bedder and tractor / handler when attaching.

Risk of entanglement in agitator. Do not reach into Cubicle bedder tub whilst engine is running on tractor / handler.

Risk of thrown or flying objects. Keep a safe distance from the Cubicle bedder when machine is working.

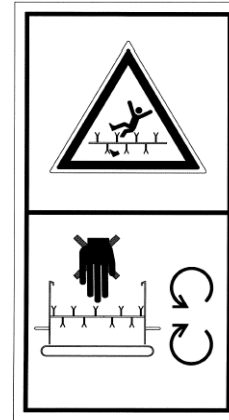
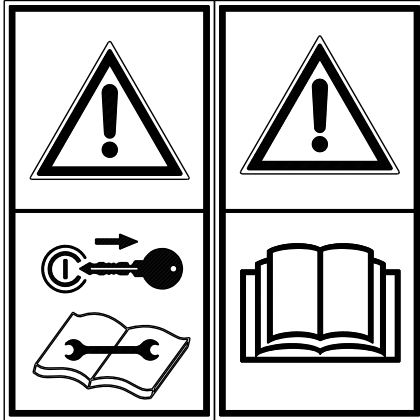

It is dangerous to touch the conveyor belt when it is in operation. There is a risk of hand entanglement.

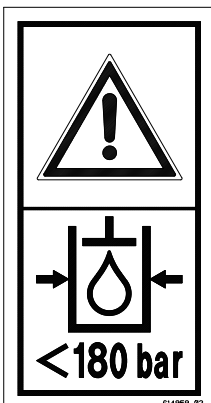

Ensure that the hydraulics are not exposed to more than 180 bar of pressure. There is a risk of damage to hydraulic components.

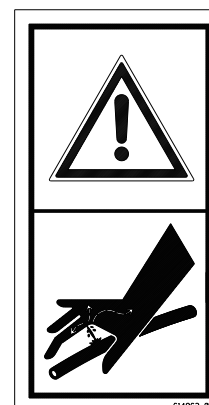

Hydraulic oil is dangerous when under pressure and can be injected into the body. Always ensure the hoses are in good order before operating.

Additional safety signs on tipping 'A' frame models only

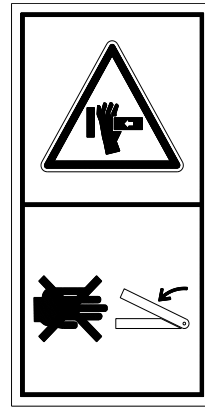
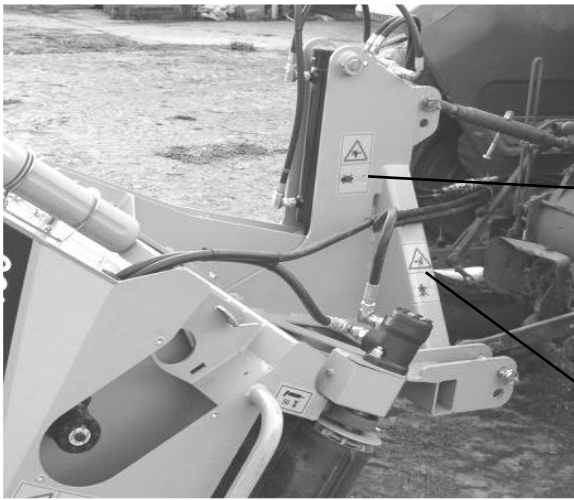

There is a crushing hazard between the two mating parts of the Tipping 'A' frame.

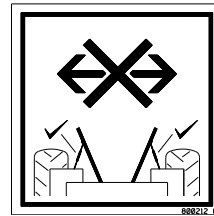

Tighten check chains to stop lateral movement when machine is mounted to a standard 3-point link.

Additional safety sign on fixed 3 point mounting models only

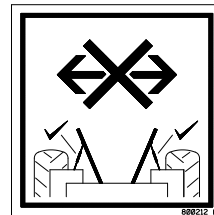

Tighten check chains to stop lateral movement when machine is mounted to a standard 3-point link.

Additional safety sign on chain drive models only



Do not open or remove safety guard while engine is running. There is a risk of hand entanglement.

2.3 ACCIDENT PREVENTION BEFORE STARTING THE MACHINE

Read the manual thoroughly.

If moving the Cubicle Bedder by overhead lifting use the designated lifting points, see section 4. Ensure that the slings / chains are rated accordingly, and that the angle of the slings / chains are set in accordance to lifting regulations.

If moving the Cubicle Bedder by forklift use the designated forklift shoes, see section 4. Ensure the forklift has enough capacity to lift the machine.

Ensure bystanders are at a safe distance when moving the Cubicle Bedder by overhead slinging or on a forklift.

If assembling tipping frame onto Cubicle Bedder, using lifting equipment, be careful not to trap fingers, due to confined space.

The Cubicle Bedder may be used only if all safety devices, e.g. detachable guards, are fitted securely and in proper working order.

Nuts and bolts should be initially checked in general and at regular intervals and tightened if necessary.

Check there are no foreign objects interfering with the Cubicle Bedder and tractor, handler or loader.

Ensure that no person is working on or inside the machine or tractor, handler or loader at any time during all stages of use. Always perform an inspection inside, around and under before starting.

2.4 ACCIDENT PREVENTION WHEN ATTACHING AND DETACHING TO THE TRACTOR, HANDLER OR LOADER.

The work of coupling and uncoupling of the Cubicle Bedder involves a high risk of injury. Follow the procedure described further through this manual for Cubicle Bedder attachment and detachment. See Sections 5.6 to 5.11.

Check that the combined weight of the Cubicle Bedder and the heaviest load of bedding material do not exceed the manufacturers recommended safe loading of axle, wheels and tyres. Smaller tractor might also require additional front weights to ensure positive steering.

Connect the Cubicle Bedder to the handler or loader using a manufacturer-approved bracket in the manner recommended in the handler or loader operator's manual. If brackets are to be welded to the Cubicle Bedder it is absolutely vital that a Professional Welder carries out the welding work.

Ensure that the machine is parked on even level ground for attaching and detaching.

Check that all observers are clear of the Cubicle Bedder and tractor, handler or loader. Warn bystanders by sounding the horn of the tractor, handler or loader several times.

Slowly drive the tractor, handler or loader towards the Cubicle Bedder – always ensure that there are no other persons in the vicinity or between the machine and tractor, handler or loader.

Connect the Cubicle Bedder to the tractor linkage using only the method recommended in the tractor's operator manual.

Ensure handler or loaders locking pins / device or tractors linkage arm pin retainers are secured once connected

Do not detach the Cubicle Bedder loaded, as stability will be reduced, always empty it first.

2.5 ACCIDENT PREVENTION WHEN USING THE HYDRAULIC SYSTEM

Due to the possibility of oil contamination on your hands it is recommended to use PPE (Personnel Protective Equipment), wear gloves, when handling hydraulic hose connectors.

Do not connect the hydraulic hoses to the tractor, handler or loader hydraulic system until you have made sure that the system is at zero pressure on both the tractor, handler or loader and the Cubicle Bedder.

Hydraulic systems can generate extremely high pressures. All piping, hoses and connections must therefore be checked regularly for leakage and visible external damage.

Do not connect to tractor, handler or loaders hydraulic system if it can deliver more than 180 bar of pressure or more than the maximum flow rate allowed, see section 5.4

Use proper and thorough means of searching for leakage and repair all damage immediately.

Spurting hydraulic oil can cause injuries and fires. Seek medical advice immediately in the event of injury.

Hydraulic systems can generate heat within its components, be aware if touching / servicing components directly after use.

2.6 ACCIDENT PREVENTION WHEN OPERATING.

The Cubicle Bedder must not be put into operation until the user has been given proper initial instructions either by the dealer or by one of Shelbourne Reynolds' representatives or employees.

One person should use the Cubicle Bedder only. When the operator identifies someone approaching or is too close for their safety, the operator shall stop operating until the person is clear again.

Bystanders need to keep a safe distance from the Cubicle Bedder and tractor, handler or loader while it is being operated. Warn bystanders by sounding the horn of the tractor, handler or loader several times and give them time to move away before starting.

Do not permit anyone other than the operator to ride on the tractor, handler or loader or allow anyone to ride on the Cubicle Bedder.

Keep children away from the Cubicle Bedder and tractor, handler or loader at all times.

In the event of a malfunction, immediately cease operation and secure the Cubicle Bedder in its stationary position. Malfunctions must be eliminated immediately.

Ensure the tractor, handler or loaders engine is turned off and key removed from ignition and handbrake applied.

Do not work around the Cubicle Bedder and tractor, handler or loader in loose clothing that might get caught up or in moving parts.

Do not go under the Cubicle Bedder unless it is securely blocked.

Always stop the engine, remove the key and apply handbrake before removing or opening any guards or clearing a blockage.

NEVER approach the machine whilst the conveyor is running.

Always replace all guards after making any adjustments or lubricating the machine. Replace or repair any damaged or missing guards immediately.

Keep hands away from moving parts i.e. conveyor belt / rollers and do not reach into hopper due to entanglement of agitator.

Inspect bedding material before loading to ensure it does not contain any foreign objects.

If manually loading the tub with material (bagged material), follow Manual handling recommendations.

Certain types of bedding material could demand the wearing of PPE (Personnel Protective Equipment) due to its fine particles or the material is a skin irritant. In this case wear face / dust mask, goggles, gloves and overalls. Keeping tractor, handler or loader windows and doors closed whilst discharging will also help.

Ensure that bystanders are not standing in the driving line of the tractor, handler or loader when loading, transporting and discharging.

When using tipping frame and loading heavy bedding material, i.e. sand, do not overload tub making tractor unstable, i.e. wheelie. Certain combinations of Cubicle Bedder model and tractor size might mean it cannot be completely filled.

When transporting a loaded Cubicle Bedder on a handler or loader carry Cubicle Bedder at a low height to ground to increase handler or loader stability.

In the event of suddenly reversing the hydraulics (conveyor and agitator drive) to clear a blockage in the tub, ensure any bystanders are clear of opposite end first.

If prolonged use of machine in buildings, or if tractor, handler or loader doors or windows are left open during use, then the operator or any bystanders are recommended to use PPE, ear defenders.

2.7 ACCIDENT PREVENTION WHEN LEAVING THE MACHINE

Park the Cubicle Bedder and tractor, handler or loader on level ground.

Apply the tractor, handler or loader parking brake.

Lower the Cubicle Bedder to the ground.

Stop the tractor, handler or loader engine and remove the ignition key. If being left unattended lock tractor, handler or loader cab.

2.8 ACCIDENT PREVENTION WHEN SERVICING / ADJUSTING THE MACHINE

The Cubicle Bedder must be maintained and repaired only by persons who are familiar with its working and have been made fully conversant with any risks involved.

Ensure that the Cubicle Bedder is on the ground or if in the raised position, that it is securely

blocked.

Stop the engine, remove the key and apply handbrake before performing any adjustments or lubrication and before opening or removing any guard.

Any malfunctions or defects, which might affect the safe operation of the Cubicle Bedder, must be immediately eliminated.

OEM replacement parts and accessories from Shelbourne Reynolds have been specially designed for use with the Shelbourne Reynolds Cubicle Bedder. Any replacement parts and accessories not supplied by Shelbourne Reynolds have not been tested and approved by us. The installation and / or the use of non-Shelbourne Reynolds products may under certain circumstances have a negative influence on the given design features of your machine and may therefore adversely affect its safe and reliable operation and your safety. Shelbourne Reynolds cannot therefore be held liable for damage or injury caused by the use of non-OEM replacement parts or accessories.

Take care not to fall into the tub on to the agitator if getting inside to adjust metering plates on 3 point fixed machines. Always tip Cubicle Bedder forward on handler or loader or tipping frame mounted machines.

When adjusting metering plates take care not to pinch fingers between plates.

If running the machine to view conveyor belt movement during belt tracking adjustment, keep at a safe distance and keep hands away from moving parts. Always stop the machine before making any further adjustments.

Always re-install all safety guards on completion of servicing.

2.9 ACCIDENT PREVENTION WHEN TAKING ON PUBLIC ROADS

Road traffic regulations must be observed when taking the Cubicle Bedder on roads, paths and other public places.

The Cubicle Bedder must be in a road-worthy condition.

Observe the maximum permissible width for road transport and fit all necessary warning signs and guards.

Fully secure guards and covers so that they cannot cause injury or damage to other users of the public place.

2.10 ACCIDENT PREVENTION WHEN CLEANING AND STORING MACHINE

Do not run the machine while cleaning.

If cleaning machine using a steam cleaner or pressure washer, follow recommended precautions given by the washing equipment manufacturer.

If getting or working inside a wet machine beware that surfaces will be slippery.

Do not climb on or over parked / stored machine, due to a risk of falling in or off.

2.11 NOISE EMISSIONS

Sound pressure level measured at operator's seat in tractor cab.	Just tractor running. (full operating speed)	Tractor window closed.	68 dB(A)
		Tractor window open.	72 dB(A)
	Tractor and Cubicle Bedder running. (full operating speed)	Tractor window closed.	70 dB(A)
		Tractor window open.	92 dB(A)

Sound pressure levels measured all around the tractor and Cubicle Bedder at a distance away of 1 metre and a height of 1.6 metres, ranged from 94 - 96 dB (A).

(The above test results were obtained using a randomly selected / modern tractor)

2.12 PROPER USE

Always make sure that the Cubicle Bedder is in a technically perfect condition and that it is used properly and for its intended purpose and entirely in accordance with the instructions given in this manual. Any malfunctions or defects, which might affect the safe operation or the Cubicle Bedder, must be immediately eliminated.

The Cubicle Bedder is intended for use on typical farms and to be employed in distributing bedding material. Any uses other than those for which the Cubicle Bedder is intended, such as transportation, will automatically exempt Shelbourne Reynolds or the supplier from it's / his liability in respect of ensuing damage. Such cases of improper use will therefore be entirely at the user's own risk.

Shelbourne Reynolds Cubicle Bedders are based on state-of-the-art technology and are manufactured in accordance with recognised safety requirements. Nevertheless the use of the Cubicle Bedder does not preclude the risk of injury to the user or third parties and / or the risk of damage to the Cubicle Bedder itself or to other materials or items of equipment.

Improper use also comprises failure to observe the instructions given in this operating manual and the manufacturer's maintenance and servicing requirements.

2.13 NO LIABILITY FOR CONSEQUENTIAL DAMAGE

Even though your Shelbourne Reynolds Cubicle Bedder has been manufactured with the utmost care and you are using it properly, fluctuations and interruptions in performance may still occur.

It is the duty of the operator / user to ensure that foreign objects, e.g. stones, metal objects etc. are not allowed to enter the Cubicle Bedder. Failure to observe this may result in damage to the machine and / or injury to the operator / user or others

Any claims for damages not directly incurred by the Cubicle Bedder cannot be accepted. By the same token, Shelbourne Reynolds cannot be held liable for any consequential damage resulting from incorrect use of the Cubicle Bedder.

SECTION 3

SPECIFICATION & DESCRIPTION

3.1 DESCRIPTION

The machine consists of a tub (a), which holds the bedding material. The machine can be optionally mounted to a tractor via a tipping 'A' frame (b), this allows the machine to self load and scoop up bulk material. It is also possible to mount the Cubicle Bedder to the tractors 3 point linkage via a fixed 3 point mounting kit (c), however this would not allow self-loading. Another option is to mount the machine to a telescopic handler or front end loader, via approved handler or loader brackets, these can be welded or bolted to the rear box sections of the machine (d).

Positioned underneath the tub is a conveyor (e), this is driven by a hydraulic motor which is used to discharge the bedding material to either the left or right hand side of the machine. A hydraulically driven horizontal rotating agitator (f) is used to loosen the bedding material in the tub ensuring that the material flows through the metering plates and onto the conveyor. The agitator is direct coupled as standard but can be optionally fitted with a reduction chain drive to give more torque capacity. The conveyor and agitator are both driven by the tractor, telescopic loader or front end loaders hydraulics. Bolt on tines (g) are fitted to the agitator which can be set in different configurations for various bedding materials.

The metering plate's (h) consist of two adjustable slides, which fit inside the tub and regulate the amount of material flowing to the conveyor belt, by adjusting the gap between them.

The machine is available in 3 sizes, named 100, 150 and 300 model in order of smallest to largest.

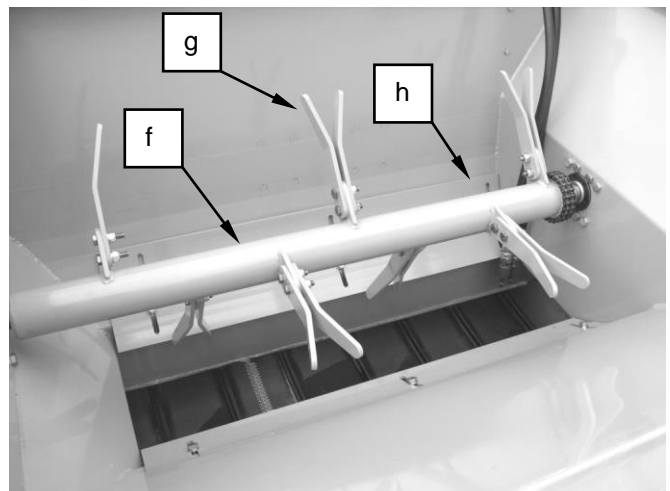
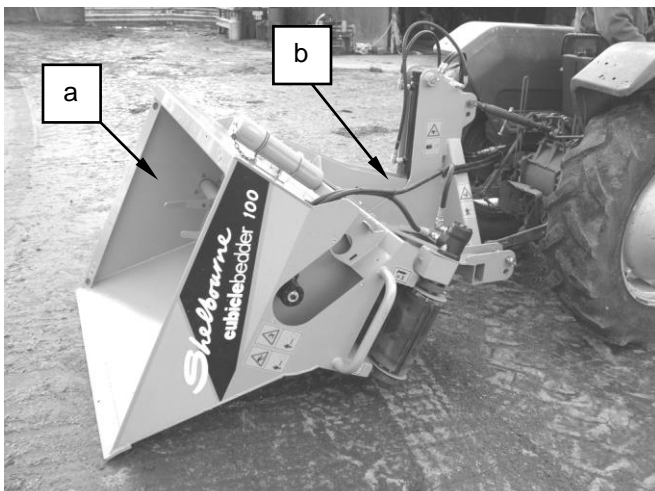
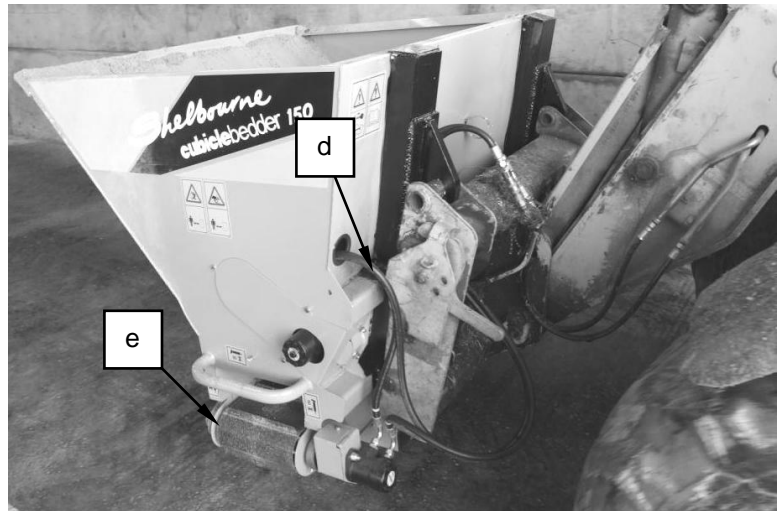
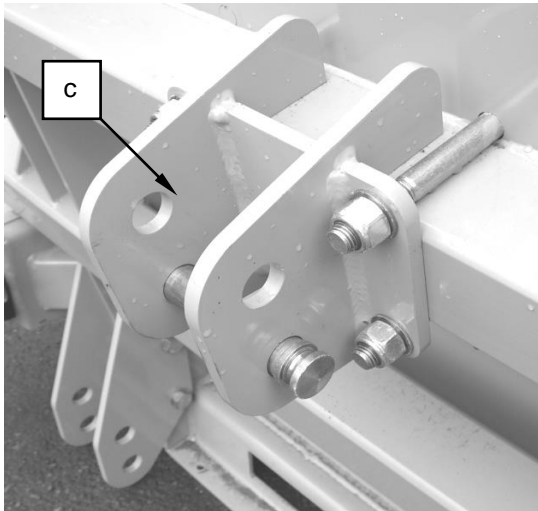

Right, left, front and rear of the machine are termed in the manual as viewed from the drivers seat with the Cubicle Bedder fitted to the front of a handler or loader.

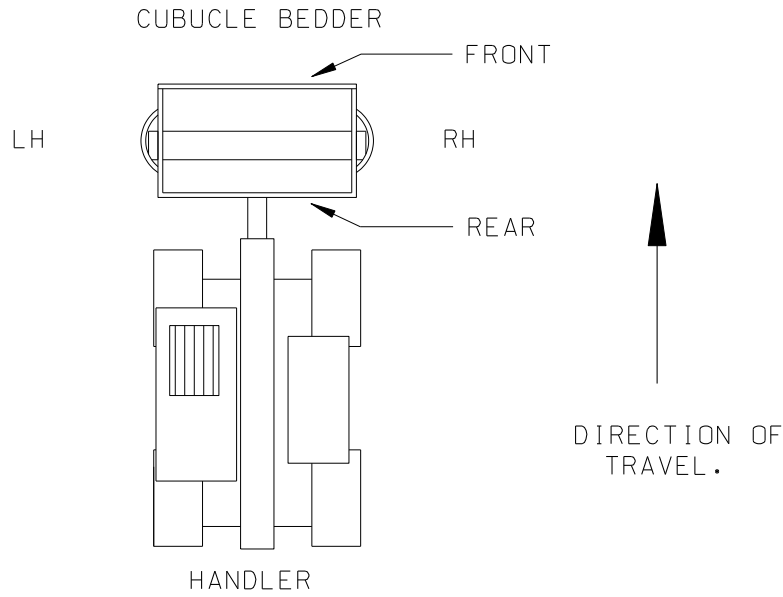

3.2 INTENDED USE

The Cubicle Bedder is intended to be used on typical farms for transporting and then discharging suitable animal bedding materials into the animal bedding area, usually cubicle beds. It should not be used as a general usage bucket for moving or transporting other materials.

3.3 TECHNICAL SPECIFICATION

Sizes and weights of basic machine are as follows: (all dimensions and weights are approximate)

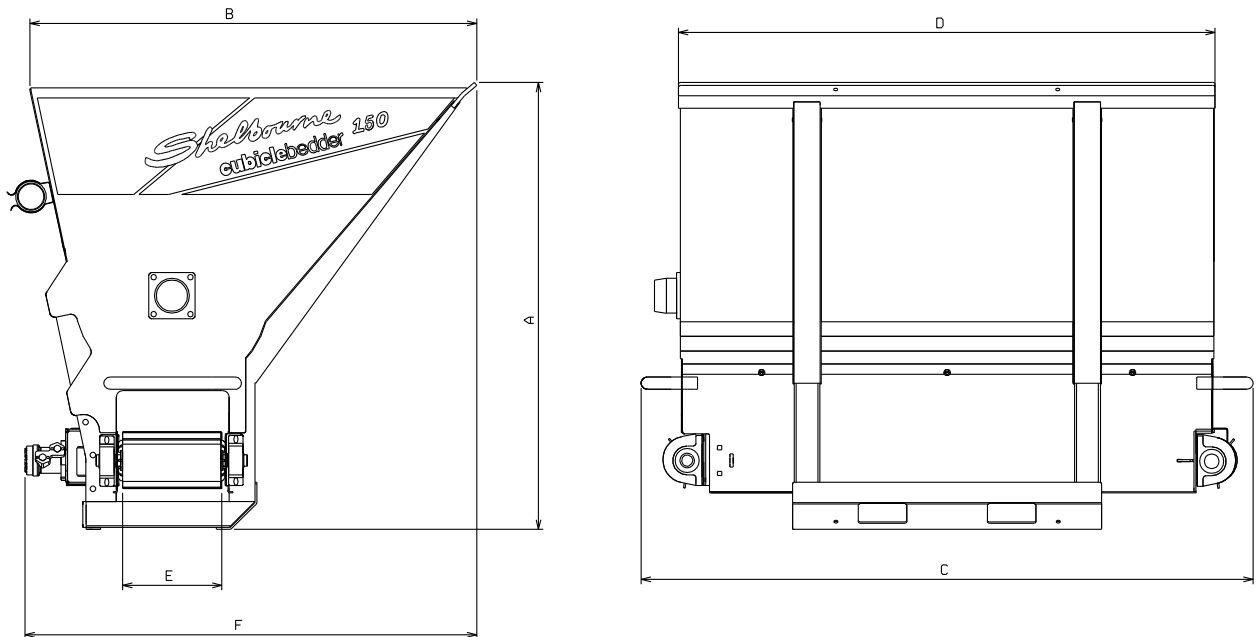

	100	150	300
Machine capacity (LEVEL)	0.6m ³	1.2m ³	1.45m ³
Overall height (A)	1170mm	1390mm	1390mm
Overall depth (F)	1235mm	1420mm	1420mm
Overall width (C)	1600mm	1900mm	2200mm
Tub width (D)	1370mm	1670mm	1970mm
Tub depth (B)	1150mm	1390mm	1390mm
Width of discharge belt (E)	0.3m	0.3m	0.3m
Min recommended tractor size	50hp	50hp	50hp
Optimum hydraulic oil flow*	30-35 litres/min	30-35 litres/min	30-35 litres/min
Max. hydraulic oil flow	60 litres/min	60 litres/min	60 litres/min
Min hydraulic oil pressure	125 bar	125 bar	125 bar
Max. hydraulic oil pressure	180 bar	180 bar	180 bar
Weight	440 kg	530 kg	580 kg

* Lower flow rates can be used with changes to the machine, please consult Shelbourne Reynolds

OPTIONS.

3 point hydraulic tipping 'A' frame kit.

Fixed 3 point linkage kit.

Agitator chain drive kit.

Conveyor drive motor variations for lower flow rates.

SECTION 4

TRANSPORTATION



Refer to Section 2 for accident prevention.

To prevent damage to the Cubicle Bedder the machine should only be moved by one of the following methods:

- (1) Using a forklift either through the forklift tine holes in the base of the machine or if laying on a suitable support pallet.
- (2) Using overhead lifting by slinging the tub with the four designated sling points.
- (3) Attaching to a tractor. (see section 5.1, 5.2, 5.6, 5.7, 5.9 & 5.10)
- (4) Attaching to a handler or loader. (see section 5.5, 5.8 & 5.11)

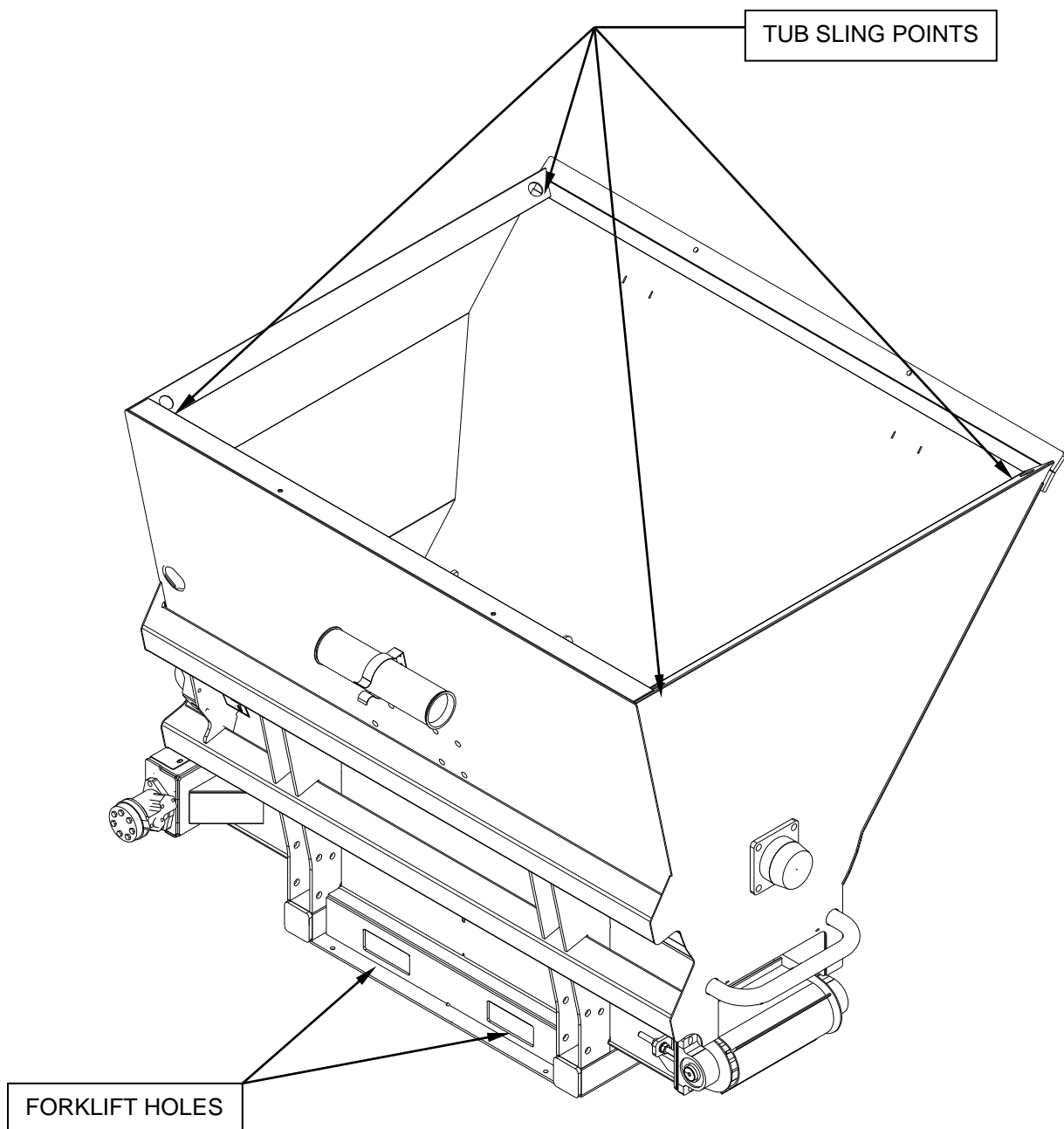

SECTION 5

PREPARATION FOR USE



Refer to section 2 for accident prevention.

The Cubicle Bedder will be delivered to the dealer fully assembled, except for specific handler or loader mounting brackets and final hydraulic connections.

However in the case of a dealer stock machine being sold then some additional assembly work might need be required e.g.

- fitment of 3 point hydraulic tipping 'A' frame kit, SRE part. no. KIT-26007
- fitment of fixed 3 point linkage kit, SRE part. no. KIT-26008
- conversion to agitator chain drive from direct drive, SRE part. no. KIT-26009
- changing conveyor drive motor to suit flow.

5.1 FITMENT OF 3 POINT HYDRAULIC TIPPING 'A' FRAME KIT

(See parts pages KIT-26007 for more details)

The tipping frame will be delivered already sub assembled with the cylinder extended i.e. set for the Cubicle Bedder in the raised position. The cylinder is PO checked so should not move unless powered hydraulically. Initial fitment of the tipping frame to the Cubicle Bedder should be done set like this.

This tipping frame assembly simply bolts on to the 2 box sections welded on the rear of the tub. It is secured using 8 bolts going through 4 clamp plates that are positioned inside the tub. The positioning of the 4 bolts around the top box section are pre determined by "knockout holes" in the rear sheet of the tub (Note use the 4 outer "knockouts" set at 288mm centres)

Using suitable lifting equipment to lift the tipping frame, sling to keep the mounting face at a similar angle to the rear faces of the 2 box sections on the tub. Carefully position the tipping frame to align knockout holes and secure with fasteners and clamp plates.

The hydraulic hose end couplings are ½" male quick release couplings suitable for a tractors double acting spool.

5.2 FITMENT OF FIXED 3 POINT LINKAGE KIT

(See parts pages KIT-26008 for more details)

This kit simply bolts on to the rear of the tub. The top link bracket fits onto the top box section using 4 bolts going through 2 clamp plates that are positioned inside the tub. The position of these are pre-determined by "knockout holes" in the rear sheet of the tub (Note use the 4 inner "knockouts" set at 144mm centres)

The 2 lower link connections are constructed by bolting on 4 lower mounting plates to the outside of the lower rear tub structure.

5.3 CONVERSION OF AGITATOR CHAIN DRIVE FROM DIRECT DRIVE

(See parts pages KIT-26009 for more details)

When bedding with chopped straw or sand, it is recommended to fit the agitator chain drive option.

This will increase the power of the agitator, which will prevent the agitator from stalling in heavy or coarse products.

It also enables a full set of standard tines to be fitted, which will reduce the chance of the bedding product from bridging in the hopper.

The kit moves the direct drive motor from directly supporting the agitator shaft to then introduce a short drive shaft, bearing and chain reduction drive to the re located motor.

5.4 CONVEYOR MOTOR OPTIONS

The optimum conveyor speed to give an ideal throwing distance is between 750-875 rpm. Depending on the hydraulic flow rate of the tractor, handler or loader there are 3 motor options available. Option 1 is fitted as standard and achieves the optimum speed with a flow rate of between 30-35 l/min. This motor is also capable of running with a maximum flow rate of 60 l/min.

Options 2 and 3 are for lower flow rates. Important - both these options have lower maximum flow rates of 50 and 40 l/min respectively.



Ensure the tractor, handler or loaders hydraulic systems maximum flow rate does not exceed the motor capabilities stated. If unsure get tractor, handler or loaders flow rate measured, don't forget to measure at high engine revs as well as idle. Note some spools have regulators to be able to control the flow rate.



Ensure the tractor, handler or loaders hydraulic systems maximum pressure cannot exceed 180bar, if unsure get checked / tested.
Not ensuring the above could lead to component damage.

If a lower flow rate option is required or if the flow rate is higher than 60 l/min please contact Shelbourne Reynolds Engineering.

Option 1	SRE Pt No MOTH04001 – Optimum flow rate of 30-35 l/min
Option 2	SRE Pt No MOTH03200 – Optimum flow rate of 24-28 l/min
Option 3	SRE Pt No MOTH02500 – Optimum flow rate of 19-22 l/min

5.5 HANDLER OR LOADER BRACKET FITMENT

Before using the Cubicle Bedder on a handler or loader, manufacturer approved brackets will need correctly fitting to the two rear box sections of the Cubicle Bedders tub.

Depending on the handler or loader in question the brackets may be bolted or welded around the rear box sections.



It is absolutely vital that a professional welder carries out the welding work.

The positioning of these brackets will vary between handler or loader manufacturer and even models. If position is not known then it is suggested to carefully situate the Cubicle Bedder centrally and in close proximity to the headstock / mounting face of the handler or loader.

Do not position the brackets too low as downwards clearance will be needed to allow the headstock / mounting face to lower and disengage out of the brackets when the Cubicle Bedder is sitting vertically on ground.

5.6 ATTACHMENT TO A TRACTOR USING FIXED 3 POINT LINKAGE

The Cubicle Bedder must be initially fitted with KIT-26008 / fixed 3 point linkage kit.

Ensure the tractor is at least the minimum recommended size and has 1 double acting spool valve.

Refer to the tractor manufacturers operators manual for more details on attachment and removal of equipment.

Follow the below procedure -

- (1) Ensure the Cubicle Bedder is sitting on firm / level ground. It might have to be on suitable blocks or pallets depending if the tractors lift linkage cannot go low enough.
- (2) Ensure there are no bystanders between tractor and Cubicle Bedder.
- (3) Reverse the tractor centrally and slowly to the machine ensuring the lift arms are aligned between the plates. Lower the arms and continue reversing until the balls in the arms align with holes in the plates.
- (4) Apply the tractors parking brake and stop its engine.
- (5) Connect the lift arms using the 2 pins and retaining lynch pins. Alternatively the tractor might be fitted with quick release lift arms allowing the balls to be initially fitted to the Cubicle Bedder and then simply hook in and activate the locking mechanism on the arms.
- (6) Adjust the tractors top link length to enable it to be attached to the machine. Secure with the top link pin and retaining lynch pin.
- (7) Start the tractor and raise the machine to the desired working height, stop the tractor.
- (8) Adjust the top link length if necessary to set the conveyor parallel with the ground.
- (9) Adjust the check chains so that there is no sideways sway and the machine sits central to the tractor.
- (10) Connect the 2 hoses for the conveyor and agitator drive to the tractors double acting spool.



5.7 ATTACHMENT TO A TRACTOR USING 3-POINT TIPPING 'A' FRAME

The Cubicle Bedder must be initially fitted with KIT-26007 / 3 point tipping 'A' frame kit.

Ensure the tractor is at least the minimum recommended size and has 2 double acting spool valves. If only 1 spool is available then only 1 service at one time can be used and the operator will have to swap in and out couplings to the spool. Refer to the tractor manufacturers operators manual for more details on attachment and removal of equipment.

Due to the Cubicle Bedder and the tipping frame initially being either delivered or later dealer fitted in the fully raised position it can give initial connection problems. This is due to the tractors lift arms not going low enough to connect to the tipping frame. If this happens then the Cubicle Bedder and tipping frame will need lifting off the ground and sitting on blocks or pallets.

Once done follow the below procedure -

- (1) Ensure the Cubicle Bedder is laying on firm / level ground in its lowest tipped position
Note – for the initial attachment only the Cubicle Bedder will be already fully raised and standing on blocks or pallets.
- (2) Ensure there are no bystanders between tractor and Cubicle Bedder.
- (3) Reverse the tractor centrally and slowly to the machine ensuring the lift arms go between the clevis on the tipping frame. Lower the arms and continue reversing until the balls in the arms align with holes in the clevis.
- (4) Apply the tractors parking brake and stop its engine.
- (5) Connect the lift arms using the 2 pins and retaining lynch pins. Alternatively the tractor might be fitted with quick release lift arms allowing the balls to be initially fitted to the Cubicle Bedder and then simply hook in and activate the locking mechanism on the arms.
- (6) Adjust the tractors top link length to enable it to be attached to the tipping frame. Secure with the top link pin and retaining lynch pin.
- (7) Connect the 2 hoses for the tipping frame cylinder control to one spool and the 2 hoses for the conveyor and agitator drive to another spool.
- (8) Start the tractor and raise the machine to the desired working height using the tractors lift arms.
- (9) Operate the tractor spool to hydraulically raise the Cubicle Bedder to the fully vertical position in relation to the tipping frame, stop the tractor.
Note – for the initial attachment only the Cubicle Bedder will be already fully raised in relation to the tipping frame. Still operate this spool for at least 10 seconds, even if little to no movement is seen, as this ensures that one side of the cylinder is full of oil.
- (10) Adjust the top link length if necessary to set the conveyor parallel with the ground.
- (11) Adjust the check chains so that there is no sideways sway and the machine sits central to the tractor.
- (12) On initial attachment only, hydraulically tip the Cubicle Bedder to its fully lowest position to fill up the second side of the cylinder.



Be aware that tipping movements could be less controlled at this stage. Following that, raise the Cubicle Bedder back to the vertical position, now knowing the cylinder is primed with oil on both sides.



Ensure that the hydraulic hoses are not taugth in the fully lowered position as well as they are not getting caught or trapped in the fully raised.

Alternatively the tipping frame can be used in conjunction with a standard quick hitch 'A' frame already attached to the 3-point linkage of the tractor.

Follow the below procedure –

- (1) Ensure the Cubicle Bedder is lying on firm / level ground in its lowest tipped position.
Note – for the initial attachment only the Cubicle Bedder will be already fully raised and standing on blocks or pallets.
- (2) Ensure there are no bystanders between tractor and Cubicle Bedder.
- (3) Reverse the tractor centrally and slowly to the machine ensuring the 'A' frame alignment to the tipping frame. Lower the lift arms / 'A' frame" and continue reversing until it is positioned to be able to be raised and connected into the female receptacle on the tipping frame. Raise arms ensuring full engagement and make sure 'A' frame locking mechanism activates to secure. (Note the tipping frame mechanism has an adjustable hitch cam plate. This can be set in 2 different hole positions as well as fine adjustment can be achieved by turning off centre cams on the fixing bolts.
- (4) Apply the tractors parking brake and stop its engine.
- (5) Connect the 2 hoses for the tipping frame cylinder control to one spool and the 2 hoses for the conveyor and agitator drive to another spool.
- (6) Start the tractor and raise the machine to the desired working height using the tractors lift arms.
- (7) Operate the tractor spool to hydraulically raise the Cubicle Bedder to the fully vertical position in relation to the tipping frame, stop the tractor.
Note – for the initial attachment only the Cubicle Bedder will be already fully raised in relation to the tipping frame. Still operate this spool for at least 10 seconds, even if little to no movement is seen, as this ensures that one side of the cylinder is full of oil.
- (10) If necessary adjust the top link length between tractor and 'A' frame to set the conveyor parallel with the ground.
- (11) Ensure the already fitted check chains allows no sideways sway and the machine sits central to the tractor.
- (12) On initial attachment only, hydraulically tip the Cubicle Bedder to its fully lowest position to fill up the second side of the cylinder. Be aware that tipping movements could be less controlled at this stage. Following that, raise the Cubicle Bedder back to the vertical position, now knowing the hydraulic cylinder is primed with oil on both sides.

5.8 ATTACHMENT TO A HANDLER OR LOADER

The Cubicle Bedder must be initially fitted with the correct handler or loader brackets. Ensure the handler or loader is at least the minimum recommended size and has 1 double acting spool valve.

Refer to the handler or loader manufacturers operators manual for more details on attachment and removal of equipment.

Follow the procedure on the next page –

- (1) Ensure the Cubicle Bedder is standing vertically on firm / level ground.
- (2) Ensure there are no bystanders between the handler or loader and Cubicle Bedder.
- (3) Slowly drive the handler or loader towards the Cubicle Bedder lowering the headstock until positioned below the mounting brackets. Lift the headstock ensuring it fully engages into the mounting brackets and continue until it just lifts the Cubicle Bedder off the ground.
- (4) Engage locking mechanism to secure Cubicle Bedder to handler or loader.
- (5) Apply the handler or loaders parking brake and stop its engine.
- (6) Finally connect the conveyor and agitator hydraulic drive hoses to the handler or loader auxiliary hydraulic outlet. These might need changing to a specific type depending on make of handler or loader.

5.9 REMOVAL FROM A TRACTOR USING FIXED 3 POINT LINKAGE

Follow the below procedure –

- (1) Ensure there are no bystanders around tractor and Cubicle Bedder.
- (2) Select a firm level site to park the machine.
- (3) Using the lift arms lower the machine to the ground. It might have to be lowered onto suitable blocks or pallets depending if the tractors lift linkage cannot go low enough.
- (4) Apply the tractors parking brake and stop its engine.
- (5) Adjust the top link so that the machine is flat on the ground and there is no pressure on the top link.
- (6) Disconnect the conveyor and agitator hoses from the tractor, replacing the dust caps.
- (7) Disconnect the top link from the Cubicle Bedder and then remove the lower lift arm pins.
- (8) Start the tractor and slowly drive away from the Cubicle Bedder and replace the pins correctly.
Alternatively the tractor might be fitted with quick release lift arms. If so simply release the ball retaining mechanism and lower the lift arms to clear the balls before driving away.

5.10 REMOVAL FROM A TRACTOR USING 3-POINT TIPPING 'A' FRAME

When attached via a standard top link :

Follow the below procedure –

- (1) Ensure there are no bystanders around tractor and Cubicle Bedder.
- (2) Select a firm level site to park the machine.
- (3) Tip the Cubicle Bedder lower using the lower / lift ram of the tipping frame.
- (4) Using the lift arms lower the machine to the ground and tip if necessary so that the Cubicle Bedder sits on its tub blade and the under tub structure.
- (5) Apply the tractors parking brake and stop its engine.
- (6) Adjust the top link so that the machine is flat on the ground and there is no pressure on the top link.
- (7) Disconnect the conveyor / agitator and the lower / lift ram hoses from the tractor, replacing the dust caps.
- (8) Disconnect the top link from the Cubicle Bedder and then remove the lower lift arm pins.
- (9) Start the tractor and slowly drive away the Cubicle Bedder and replace the pins correctly.
Alternatively the tractor might be fitted with quick release lift arms. If so simply release the ball retaining mechanism and lower the lift arms to clear the balls before driving away.

When using a standard quick hitch 'A' frame :

Follow the below procedure –

- (1) Ensure there are no bystanders around tractor and Cubicle Bedder.
- (2) Select a firm level site to park the machine.
- (3) Tip the Cubicle Bedder lower using the lower / lift ram of the tipping frame.
- (4) Using the lift arms lower the machine to the ground and tip if necessary so that the Cubicle Bedder sits on its tub blade and the under tub structure.
- (5) Apply the tractors parking brake and stop its engine.
- (6) Disconnect the conveyor / agitator and the lower / lift ram hoses from the tractor, replacing the dust caps.
- (7) Release the 'A' frame locking mechanism.
- (8) Start the tractor, lower the lift arms so the released 'A' frame clears the tipping frame receptacle and slowly drive away from the Cubicle Bedder.

5.11 REMOVAL FROM A HANDLER OR LOADER.

Follow the below procedure –

- (1) Ensure there are no bystanders around handler or loader and Cubicle Bedder.
- (2) Select a firm level site to park the machine. It is recommended that the Cubicle Bedder is parked in the upright position, sitting on the under tub box section structure.
- (3) With the Cubicle Bedder just above the ground apply the handler or loaders parking brake and stop its engine.
- (4) Remove the conveyor and agitator hose from the handler or loader and replace dust caps.
- (5) Release the locking mechanism that secures the Cubicle Bedder to the handler or loaders headstock.
- (6) Start the loader or handler and lower the Cubicle Bedder to the ground, ensuring the base sits flat, continue lowering until the machine is disconnected from the handler or loader. Carefully reverse away from the Cubicle Bedder.

5.12 INITIAL MACHINE RUN UP

Once the Cubicle Bedder is correctly attached to the tractor, handler or loader it can then be run up.

Firstly check –

- (1) There are no foreign objects in the tub or on the conveyor belt. Note spare agitator tines could be tie wrapped on to the agitator shaft, if so remove.
- (2) Ensure the conveyor belt is tensioned correctly and not sagging and contacting the under the tub structure, see section 7.3
- (3) Ensure the chain drive is tensioned correctly (see section 7.2) and the guard is fitted. (optional drive)

Follow the below procedure –

- (1) Ensure there are no bystanders around tractor, handler or loader and Cubicle Bedder.
- (2) Warn bystanders by sounding the horn several times. allowing time for them to move away.
- (3) Start tractor, handler or loaders engine.
- (4) If the Cubicle Bedder is sitting on the ground raise up approx. 500mm above ground. If using the tipping frame or on handler or loader raise tub to fully vertical position.

- (5) With the engine revs at idle, slowly engage the spool driving the conveyor and agitator. Note the direction of rotation of the conveyor. Increase the engine rev's bearing in mind the maximum flow rates allowed, see section 5.4. Run for approx. 30 seconds.
- (6) Disengage spool and idle back engine rev's, let the machine stop.
- (7) Engage the spool this time in the opposite direction, increase the engine rev's and again run for 30 seconds.
- (8) Disengage spool, idle back the engine and then stop.
- (9) Inspect to see if conveyor belt is tracked to the centre of the rollers. If not then adjust tracking (see section 7.3)
- (10) Check for any hydraulic oil leaks.

5.13 METERING PLATES

Before filling / using the machine with bedding material the metering plates must be adjusted to provide a suitable gap in order to obtain the desired discharge rate. The two plates fit inside the tub and can be moved by slackening three bolts on each using a 17mm spanner. The size of the gap will determine the rate at which the material flows to the belt and will vary for different forms of material. The ideal gap will be established through fine-tuning however the table below acts as a starting guide.



Ensure the Cubicle Bedder is parked on an even surface, with the engine stopped and ignition key removed whilst working in the tub. Having the machine tipped forward will also make it easier than if in the vertical position.

Adjust both panels evenly to achieve the gap.

BEDDING MATERIAL	GAP BETWEEN METERING PLATES
FINE SAWDUST	20-40mm
COARSE SAWDUST	30-60mm
WOOD SHAVINGS	50-150mm
LONG MATERIAL/CHOPPED STRAW	150-300mm
SAND	50-75mm

5.14 AGITATOR TINES

Before use the agitator tine configuration might need changing depending on the material to be bedded. The standard factory set up for the agitator tines are shown on the diagram on the next page.

Extra standard tines are supplied loose, along with a set of shorter tines. These may have to be fitted / swapped over depending on the product being bedded.

It is again a case of fine tuning the agitator tine set-up to achieve the best results.

See table on following page to act as guide for different materials.



Ensure the Cubicle Bedder is parked on an even surface, with the engine stopped and ignition key removed whilst working in the tub. Having the machine tipped forward will also make it easier than if in the vertical position.

CB100 standard agitator tine set up

7 x standard tines (260178 01) and 1 x RH end tine (260203 01) fitted.
6 x standard tines (260178 01) and 7 x short tines (260205 01) send loose.

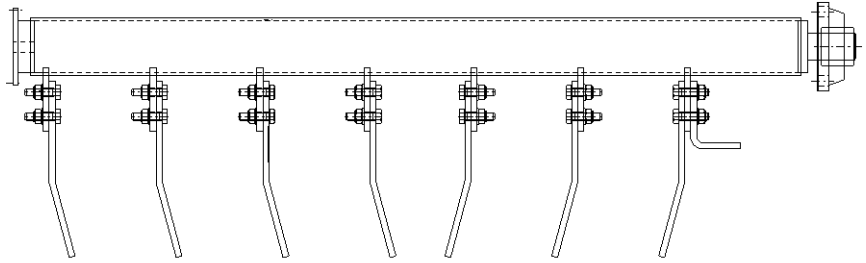

CB150 standard agitator tine set up

9 x standard tines (260178 01) and 1 x RH end tine (260203 01) fitted.
8 x standard tines (260178 01) and 9 x short tines (260205 01) send loose.

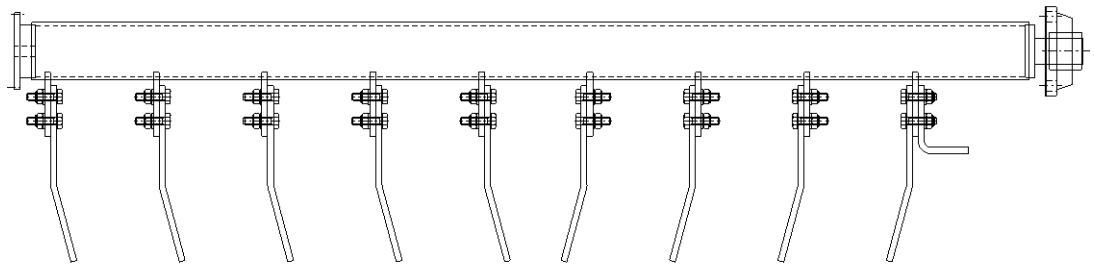

M10 x 40mm
setscrews,
orientation
as shown.

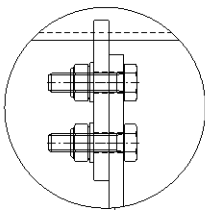

CB300 standard agitator tine set up

11 x standard tines (260178 01) and 1 x RH end tine (260203 01) fitted.
10 x standard tines (260178 01) and 11 x short tines (260205 01) send loose.

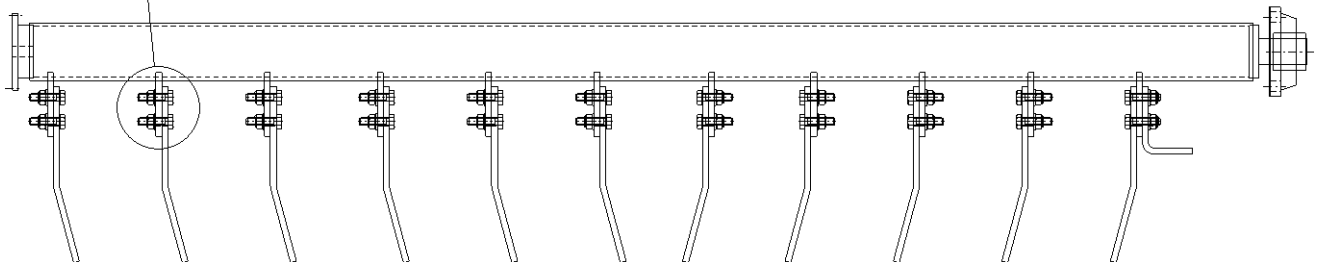

BEDDING MATERIAL	TINE CONFIGURATION
FINE SAWDUST	FULL SET OF PAIRED STANDARD TINES
COARSE SAWDUST	FULL SET OF PAIRED STANDARD TINES
WOOD SHAVINGS	FULL SET OF PAIRED STANDARD TINES
LONG MATERIAL CHOPPED STRAW	REPLACE PAIRED STANDARD TINES WITH SHORT SINGLE TINES (Pt No. 260205 01). REDUCE TINE NUMBERS IF DRIVE THEN STALLS
SAND	STANDARD FACTORY SET-UP AS SHOWN ABOVE

SECTION 6

OPERATION



Refer to section 2 for accident prevention.

6.1 LOADING THE MACHINE

Before loading the machine activate the auxiliary hydraulic supply, which controls the conveyor and agitator to ensure that all components are turning correctly and freely. Activating the auxiliary control in the other direction will change the direction of travel of both the conveyor and agitator. Familiarise yourself with these controls.

Machines that are fitted with a standard top link can only be filled manually or by an overhead hopper, in either case fill the machine with bedding material until the tub is full.



Note (150 & 300 Models Only)

When filling with sand, only half fill the tub unless the machine is fitted with the Agitator chain drive option.



Check that the combined weight of the Cubicle Bedder and the load of bedding material does not exceed the tractor / handlers recommended safe loading of axle, wheels & tyres.

Machines fitted with a 3-point tipping frame or fitted to a handler or loader can be filled from a bulk pile of bedding material on the ground

Use the below procedure :

- (1) Check there are no foreign objects in the tub or on the conveyor belt.
- (2) Ensure there are no bystanders too close around tractor, handler or loader and Cubicle Bedder.
- (3) Warn any bystanders by sounding the horn several times, allowing time for them to move away.
- (4) Start tractor, handler or loaders engine.
- (5) If the Cubicle Bedder is sitting on the ground raise up above the ground. If using the tipping frame or on handler or loader raise tub to fully vertical position.
- (6) Drive to and stop just in front of heaped material. It is important that heaped material should be kept free of foreign objects.
- (7) Lower the machine to the ground and operate the lift / lower ram of the tipping frame or crowd the handler or loader forwards until the tub blade is touching the ground. The machine may need to be lifted during this process to allow it to pivot and so the under tub structure is just clear of the ground.
- (8) Reverse / drive the tractor, handler or loader with Cubicle Bedder into the pile until the tub is full.
- (9) Operate the lift / lower ram or crowd the handler or loader back until the conveyor is parallel with the ground, the machine may need to be lowered during this process to allow it to pivot.
- (10) Raise the machine to a suitable height for transport. Keeping the machine as low to the ground as practically possible will improve the stability during transport.
- (11) Drive / reverse the tractor, handler or loader and Cubicle Bedder away from the heap.

6.2 DISCHARGING THE BEDDING MATERIAL

- (1) When the tractor, handler or loader and Cubicle Bedder are positioned ready to start bedding, beside the first cubicle bed, adjust the machine height to get the desired discharge distance and ensure the conveyor is parallel to the ground.



Check there is nobody close or in the driving line of the machine before starting to discharge the bedding material.

- (2) With the engine rev's at idle activate the tractor, handler or loaders auxiliary hydraulic spool to commence the discharge to the side needed. Both the conveyor and agitator will start rotating together.
- (3) As soon as started increase the engine rev's and drive forwards allowing bedding material to be discharged.
- (4) Continue driving and discharging until either the tub becomes empty or the need to stop, i.e. at the end of the row of beds or there is an obstacle in the way. At this stage simply disengage the tractor, handler or loaders hydraulic spool and reduce the engine revs.

If the discharge rate or spread pattern is not what is required then fine tuning will be needed.

6.3 FINE TUNING OF DISCHARGING THE BEDDING MATERIAL

DISCHARGE RATE

The discharge rate is governed by a number of factors ;

- (1) The setting of the metering plates gap, as mention in section 5.13.
- (2) The forward speed of the tractor, handler or loader.
- (3) The speed of the conveyor, which is controlled by the oil flow rate to the conveyor. This can be changed by varying engine revs or maybe varying a flow controller setting on the hydraulic spool if tractor, handler or loader has one fitted.
A different size motor could also have been fitted, see section or fitting a different size hydraulic motor, see section.5.4

These three factors might need to be adjusted to obtain the desired discharge rate for different bedding material being used.

SPREAD DISTANCE

The distance which bedding material can be thrown is dependent on ;

- (1) The speed at which the conveyor runs (see point 3 above).
- (2) The height at which the machine is off the ground.

Adjust these factors until the desired spread distance is achieved.

The type of bedding material being used i.e. lighter, finer materials like sawdust, will not be able to be thrown as far as heavier, denser materials like sand.

6.4 CLEARING A BLOCKAGE

If during discharging the bedding material the agitator stalls for some reason, follow the below procedure ;

- (1) Bring the tractor, handler or loaders forward movement to a stop, idle back the engine revs.
- (2) Stop the hydraulic spool driving the agitator and conveyor.
- (3) Check if OK to run the conveyor in the opposite direction i.e.. no bystanders close etc.....
- (4) For a few seconds only, operate the hydraulic spool in the opposite direction, checking to see the agitator is turning.
- (5) If it turns OK then next try running the conveyor back to the original direction. If it runs then re commence bedding.
- (6) If it does not then repeat steps (2) - (5) again.
- (7) If the blockage is still not cleared then, put hydraulic spool in neutral, lower the Cubicle Bedder onto the ground, apply the parking brake, stop the engine and remove the ignition key.
- (8) Look in the tub and investigate if there is a foreign object that can be easily seen and removed. If the tub has too much bedding material covering the agitator then this might need tipping out, back onto the heap, or manually unloading if 3 point fixed mounted.
- (9) Now the tub is empty remove the foreign object, reload and commence discharging.

SECTION 7

MAINTENANCE AND STORAGE



Refer to sections 2 for accident prevention.

The Cubicle Bedder is designed to be a low maintenance machine. The only required maintenance is regular lubrication, belt and chain tensioning (if chain drive option is fitted).

7.1 LUBRICATION

Each machine has five greaseable bearings. Lubricate all five bearings before using the machine for the first time and every 50 hours or 2 weeks thereafter.

If the machine is fitted with an agitator chain drive option, there is an extra remote grease nipple to grease the bearing, which is mounted behind the drive sprocket.

If the machine is equipped with a hydraulic tipping frame, a further 2 grease points are fitted.



Conveyor bearings
both sides – grease
every 50 hours

Lubricate chain
every 50 hours

50-hour grease points



Note - To lubricate the chain only the one guard (a) needs removing to gain access. The 3 fasteners (b) that retain this simply need loosening by 1 – 2 turns to then allow the guard to slide so as the keyhole aligns with the set screws flanged head to release it. These fasteners cannot be fully removed as they are retained to the machine.

 Do not run the machine with the guard removed, only lubricate the chain while it is static.
Replace the guard and tighten fasteners after lubricating.

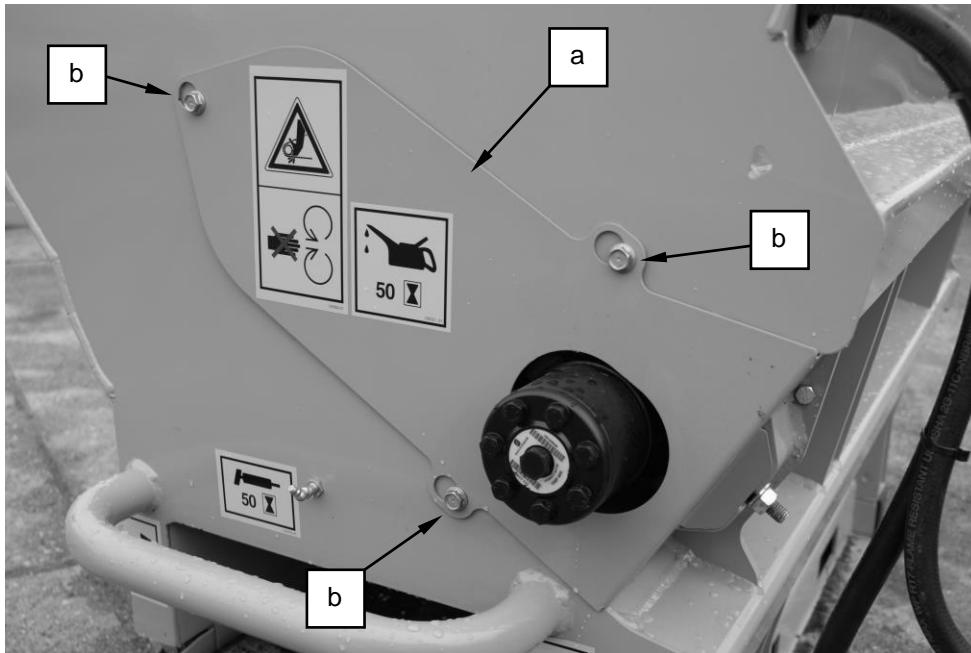

7.2 AGITATOR CHAIN DRIVE TENSION

To obtain the full life of the chain drive, regular chain tension adjustment should be carried out. The total slack in the chain can be determined by counter rotating the sprockets so one strand is taut, and then measuring the total sag between the chain and a straight edge midway between the sprockets. In this case the sag should be between 3 & 5mm.

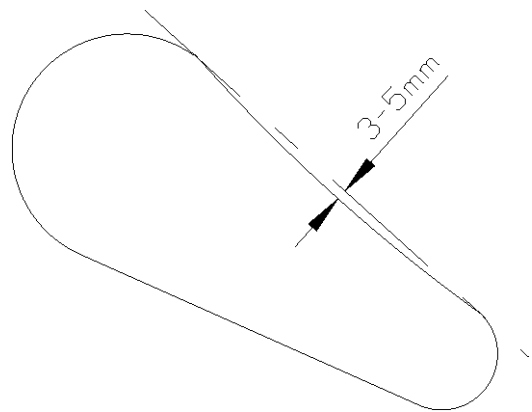

To access chain to adjust only the one guard (a) needs removing, see above note, chain lubrication.

 Do not run the machine with the guard removed.
Replace the guard and tighten fasteners after adjusting tension.

7.3 BELT TENSIONING AND TRACKING

If the belt becomes slack or is rubbing against one side of the tub, using a 19mm spanner follow the steps below:

- (1) With the belt stationary tighten the belt by moving the adjusters an equal amount out from the machine
- (2) Start the tractor, loader or handler and run the belt with no load to its full speed
- (3) If the belt begins to track to one side of the roller, stop the conveyor and switch of the tractor, handler or loader. Tension the bearing that the belt is tracking towards to move the belt towards the opposite bearing
- (4) Start the tractor, handler or loader and run the conveyor.
- (5) Repeat steps 3 and 4 until the belt is riding true to the pulley.
- (6) Once the belt is centred reverse the direction of travel of the conveyor. If the belt again runs off centre split the difference of run out between the two directions of travel.

7.4 STORAGE

- (1) Clean the machine thoroughly
- (2) Apply a rust inhibitor or oil to shiny tub surfaces, shafts, chains, sprockets, bearings and motors
- (3) Grease all bearings
- (4) Run machine to circulate grease and remove any water
- (5) Slacken off belt & chain tensioners
- (6) Store under cover